

성토부 2W가드레일(RS-09-P) SB2등급

분체도장 페인트No 12178 EX8816-L_GREEN(WT)H

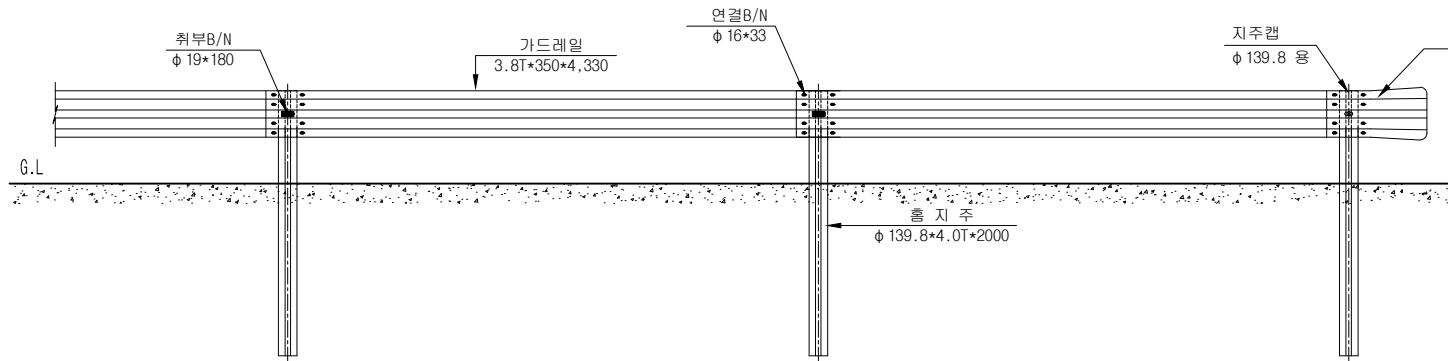

RAIL ELEVATION SCALE: NONE

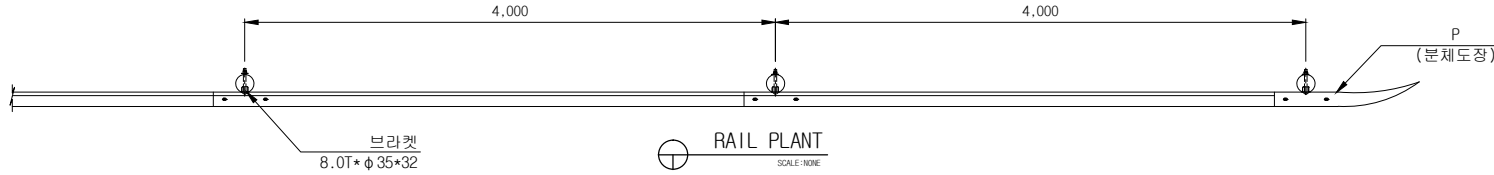
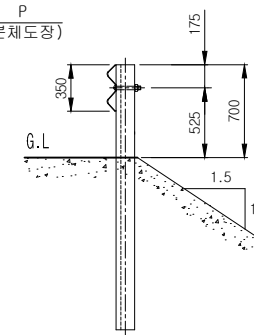

SIDE ELEVATION SCALE: NONE

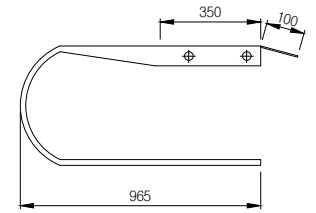

라운드레일 SCALE: NONE

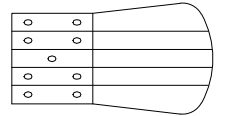

엔드레일 SCALE: NONE

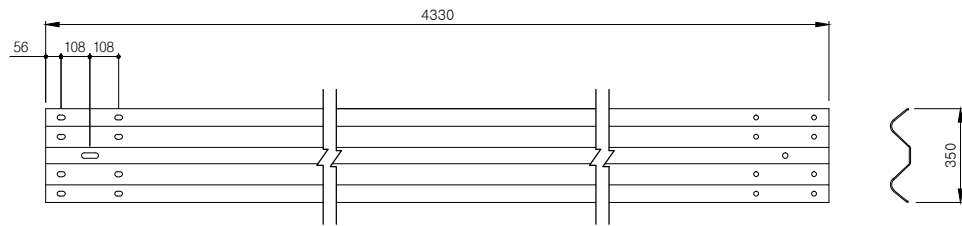

가드레일 SCALE: NONE

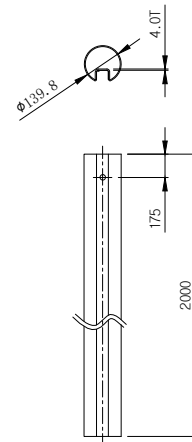

흙지주 SCALE: NONE

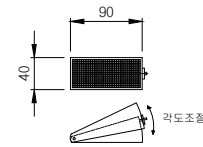

KD반사체 SCALE: NONE

표준구간(경간당)

품명	규격	단위	수량	비고
가드레일	3.8T*350*4.330	매	1	용융도금
흙지주	φ139.8*4.0T*2000	본	1	용융도금
지주캡	φ139.8용	EA	1	용융도금
취부B/N	φ19*180	조	1	용융도금
연결B/N	φ16*33	조	8	용융도금
브라켓	8T*φ35*32	EA	1	용융도금
KD반사체	40*90	EA	1	

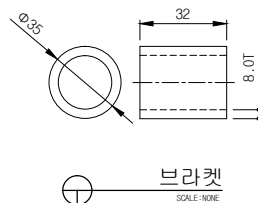
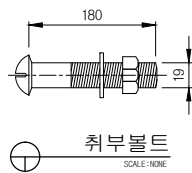
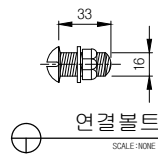

도면명	2W가드레일	등급	SB2	용도	성토부용	모델명	RS-09-P
공사명		날짜	2017.06.	축척	NON	도면번호	

(주)금동강건



경남 밀양시 초동면 명성리 2467번지 초동농공단지 내
TEL:055)-391-1717, FAX:055)-391-4600
도로안전시설물 전문 생산업체