

# 2W 표준 노측용 SB4 (성토부 RS-03)

## 완충브라켓 상세도

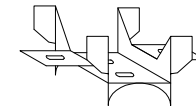

사시도

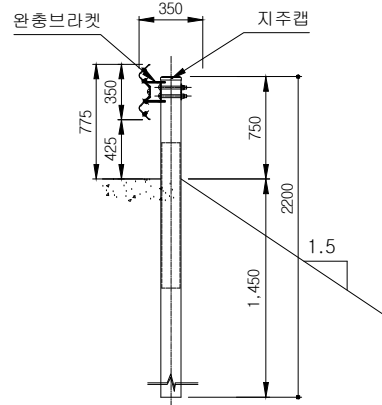
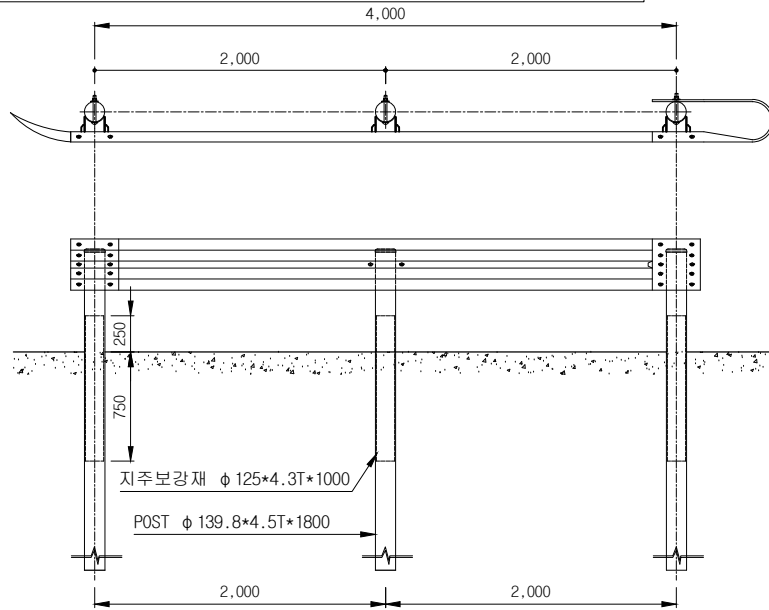
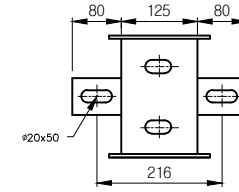

정면도

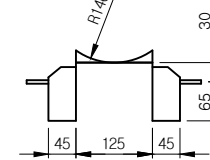

평면도

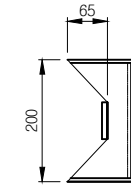

측면도

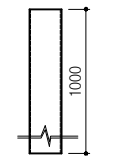
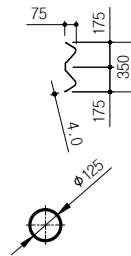
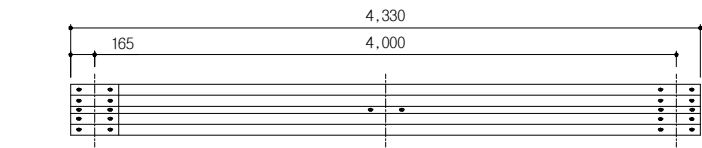
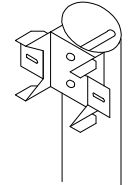

지주보강재

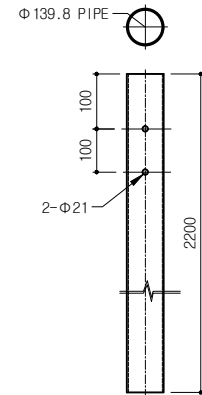

PIPE POST 상세도

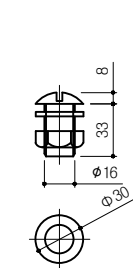

JOINTING B/N (φ16\*33)

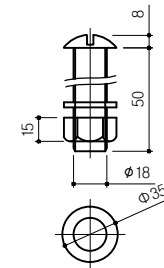

SETTING B/N (φ18\*50)

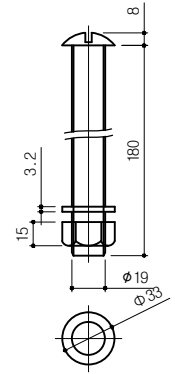

SETTING B/N (φ19\*180)

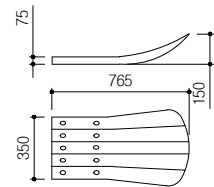

단부레일 상세도

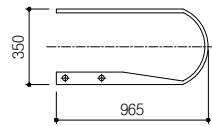

지주캡 상세도

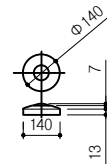

### 자재리스트

1경간(4M)당 재료표

No.	품목	규격	단위	수량	재질	방식처리
1	GUARD RAIL	4.0T*350*4,330	매	1	SS400	용융아연도금
2	PIPE POST	φ139.8*4.5T*2,200	본	2	SS400	용융아연도금
3	지주 CAP	φ139.8용	EA	2	SPHC	용융아연도금
4	완충브라켓	3.2T*125*95	EA	2	SS400	용융아연도금
5	SETTING B/N	φ19*180	EA	4	SS400	용융아연도금
6	JOINTING B/N	φ16*33	EA	8	SS400	용융아연도금
7	SETTING B/N	φ18*50	EA	4	SS400	용융아연도금
8	지주보강재	φ125*4.3T*1000	본	2	STK400	용융아연도금

(주)제일산업외

도로 안전 부대시설 표준도

REV. No.

최종작성일

2013. 10.

도면  
제목

2W 표준 노측용 SB4 조립도  
(성토부 RS-03)

도면  
번호