

3W 일반 원가드레일 (KDWT-50)

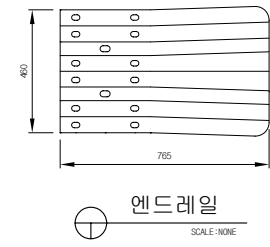
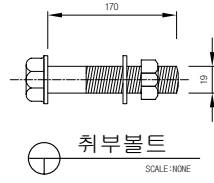
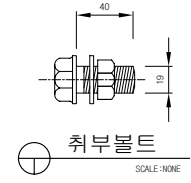
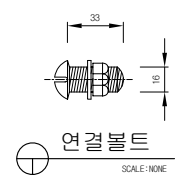
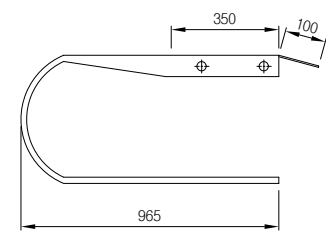
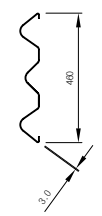
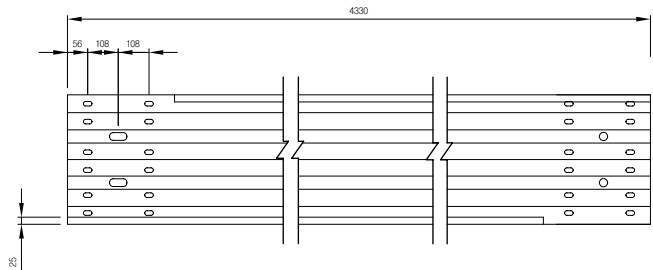
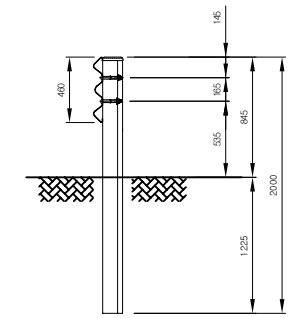
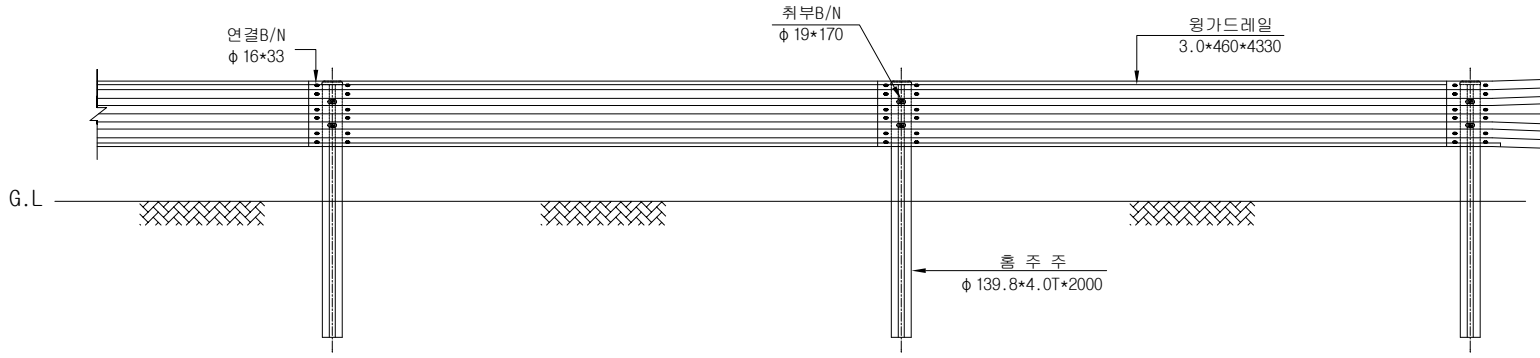
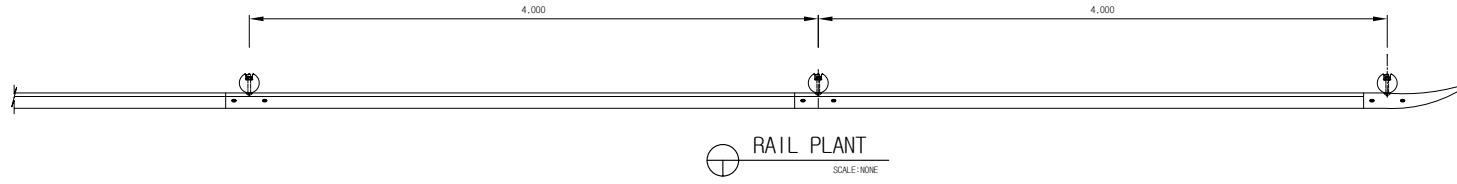

표준구간 (경간당)

품명	규격	단위	수량	비고
가드레일	3.0T*460*4330	매	1	용융도금
흙주주	φ 139.8*4.0T*2000	본	1	용융도금
주주캡	φ 139.8용	EA	1	용융도금
연결B/N	φ 16*33	SET	12	용융도금
취부B/N	φ 19*170	SET	2	용융도금

단부구간 (개소당)

품명	규격	단위	수량	비고
엔드레일	3.2T*460*765	EA	1	용융도금
흙주주	φ 139.8*4.0T*2000	본	0.5	용융도금
주주캡	φ 139.8용	EA	0.5	용융도금
연결B/N	φ 16*33	SET	6	용융도금
취부B/N	φ 19*170	SET	1	용융도금

도면명 Drawing	3w일반원가드레일	설계 Design	날짜	도면번호	(주)금동강건 KUMDONG	경남 밀양시 초동면 명성리 2467번지 초동농공단지 내 TEL:055)-391-1717, FAX:055)-391-4600 도로안전시설물 전문 생산업체
공사명 Project		제도 Drawing	축척 NON	KDWT-51		