

3W 노측용 원가드레일(KDWT-50) SB3등급

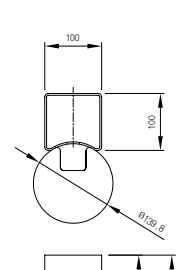

표준구간(경간당) (4M/18간)

품명	규격	단위	수량	비고
가드레일	3.2T*460*4330	매	1	용융도금
흙주주	$\phi 139.8 \times 4.0T \times 2000$	본	2	용융도금
주주캡	$\phi 139.8$ 용	EA	2	용융도금
연결B/N	$\phi 16 \times 33$	SET	12	용융도금
취부B/N	$\phi 19 \times 170$	SET	4	용융도금
취부B/N	$\phi 19 \times 40$	SET	4	용융도금
완충브라켓	3.2T*100*460	EA	2	용융도금

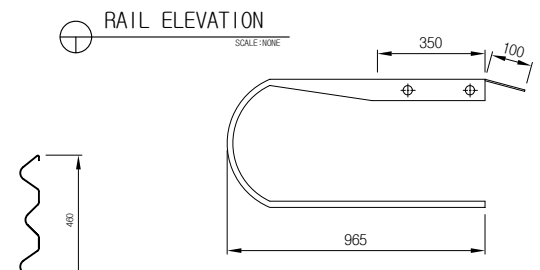
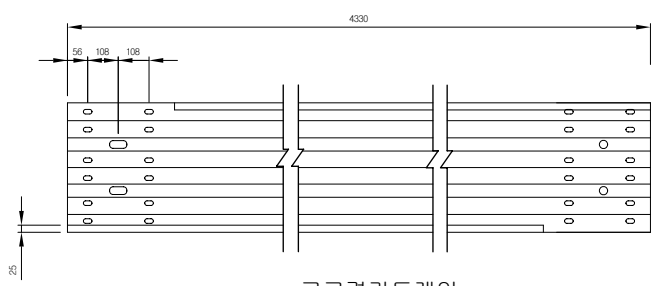
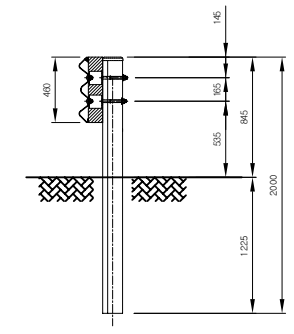
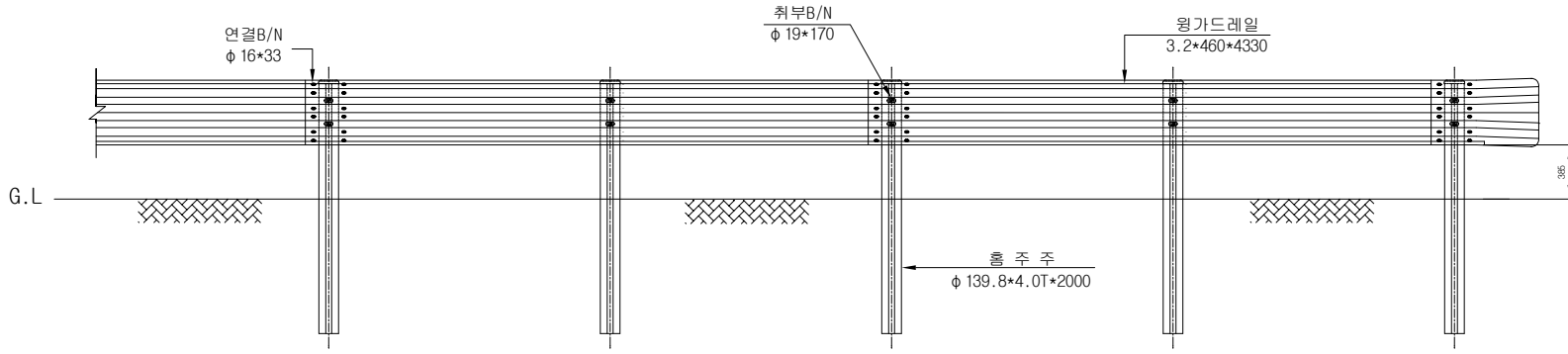
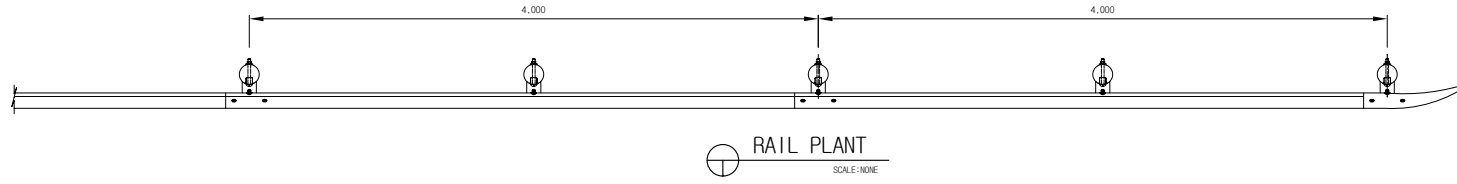
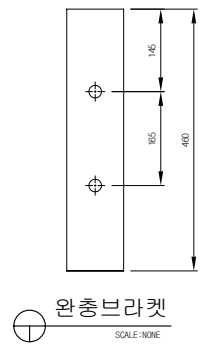
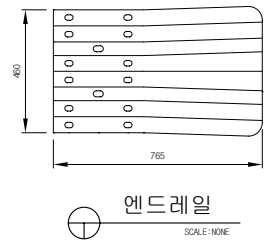
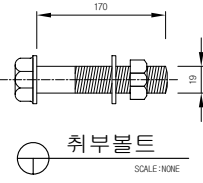
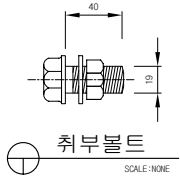
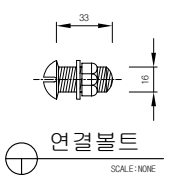

단부구간(개소당) (4M/18간)

품명	규격	단위	수량	비고
엔드레일	3.2T*460*765	EA	1	용융도금
흙주주	$\phi 139.8 \times 4.0T \times 2000$	본	0.5	용융도금
주주캡	$\phi 139.8$ 용	EA	0.5	용융도금
연결B/N	$\phi 16 \times 33$	SET	6	용융도금
취부B/N	$\phi 19 \times 170$	SET	1	용융도금
취부B/N	$\phi 19 \times 40$	SET	1	용융도금
완충브라켓	3.2T*100*460	EA	0.5	용융도금

도면명 Drawing	노측원가드레일	설계 Design	날짜	도면번호	(주)금동강건 KUMDONG
공사명 Project		제도 Drawing	축척 NON	KDWT-50	

경남 밀양시 초동면 명성리 2467번지 초동농공단지 내
TEL:055)-391-1717, FAX:055)-391-4600
도로안전시설물 전문 생산업체