

2W윙가드레일(성토부 사면용)(KDWG-14) SB2등급

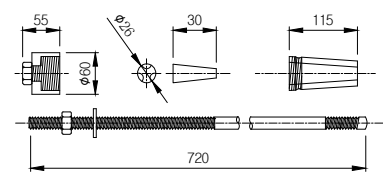
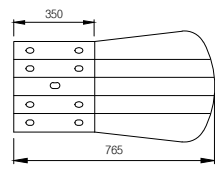
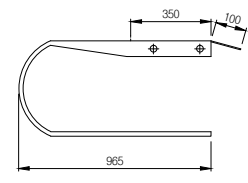
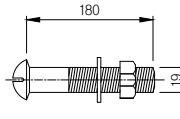
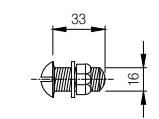
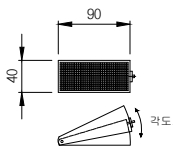
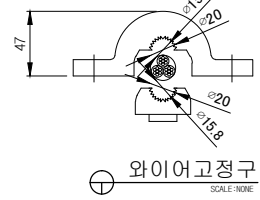
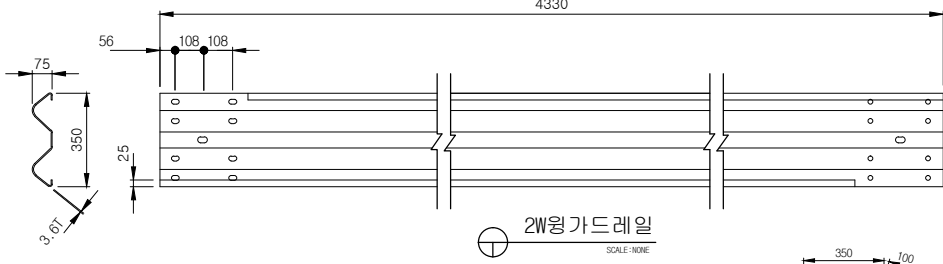
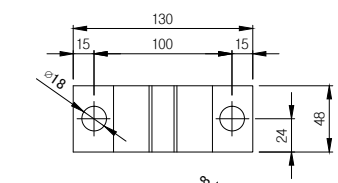
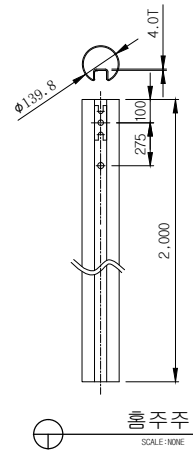
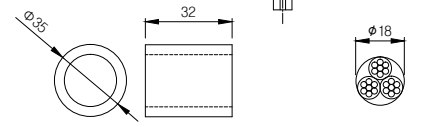
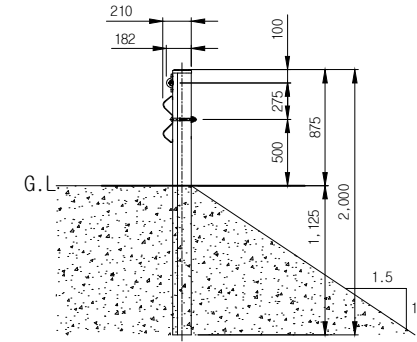
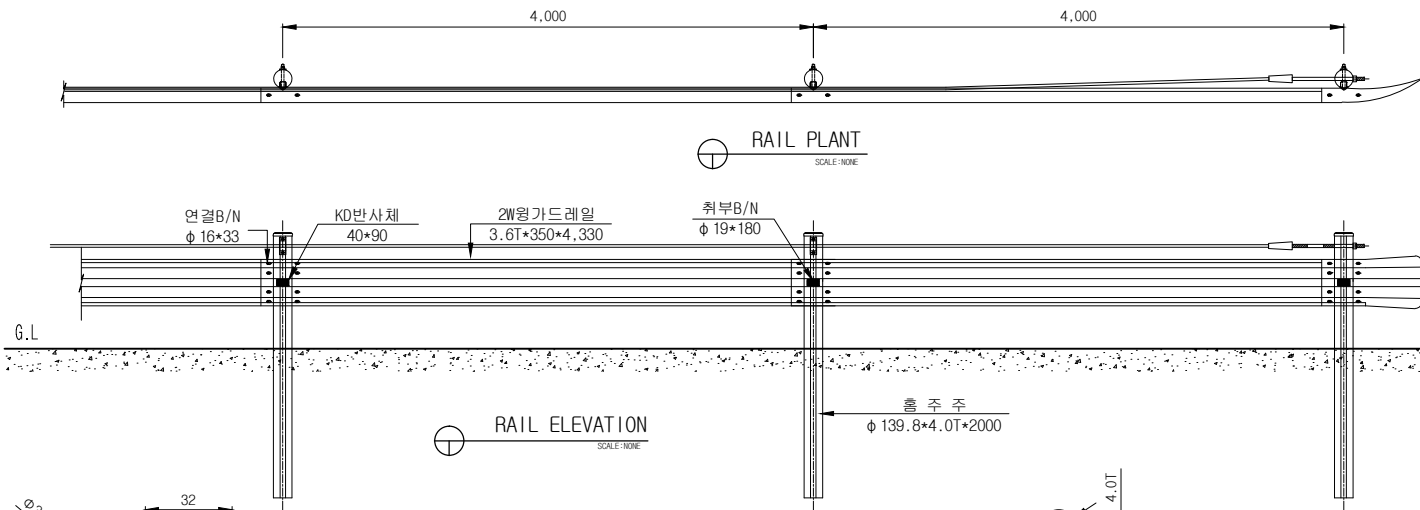

표준구간 (4M/1경간)

품명	규격	단위	수량	비고
2W윙가드레일	3.6T*350*4,330	매	1	SS400
흙주주	φ 139.8*4.0T*2000	개	1	SS400
주주캡	φ 139.8용	EA	1	
취부B/N	φ 19*180	조	1	
연결B/N	φ 16*33	조	10	
와이어로프	φ 18*3*7	M	4	
와이어고정구	48*130	조	1	AL6061 T6
브라켓	8T*φ 35*32	EA	1	
KD반사체	40*90	EA	1	

단부구간 (개소)

품명	규격	단위	수량	비고
앤드(라운드)레일	4.0T*350*765(965)	EA	1	SS400
흙주주	φ 139.8*4.0T*2000	개	0.5	SS400
주주캡	φ 139.8용	EA	0.5	
취부B/N	φ 19*180	조	0.5	
연결B/N	φ 16*33	조	4	
KD스프라이스	φ 25*720	조	1	
브라켓	8T*φ 35*32	EA	0.5	
KD반사체	40*90	EA	0.5	

도면명 Drawing	2W윙가드레일 (성토부 사면용)	설계 Design	날짜	2015. 11. 02	도면번호	KDWG-14	(주)금동강건 	경남 밀양시 초동면 초동농공단지길 56 TEL:055)-391-1717, FAX:055)-391-4600 도로안전시설물 전문 생산업체
공사명 Project		제도 Drawing	축척	NON				