

1단 강재방호책 (KDSB-05)

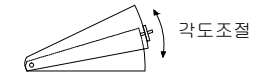

삼각반사체
SCALE: NONE

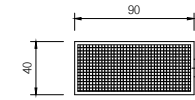
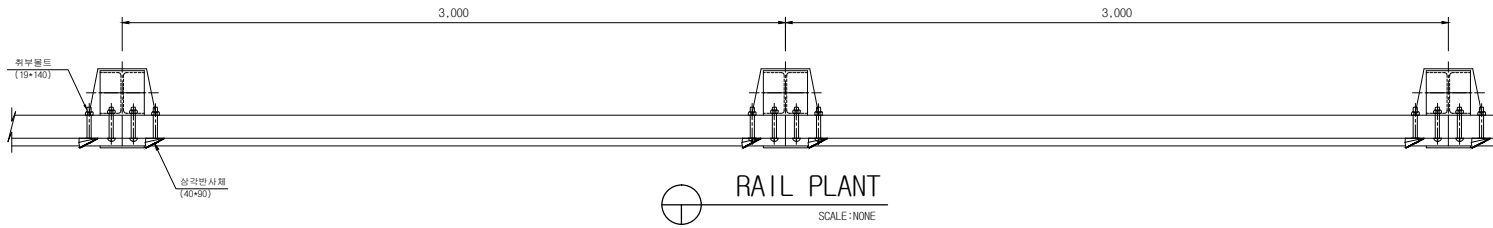
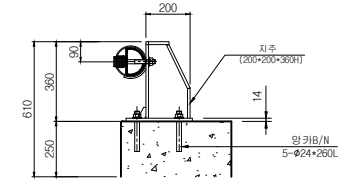
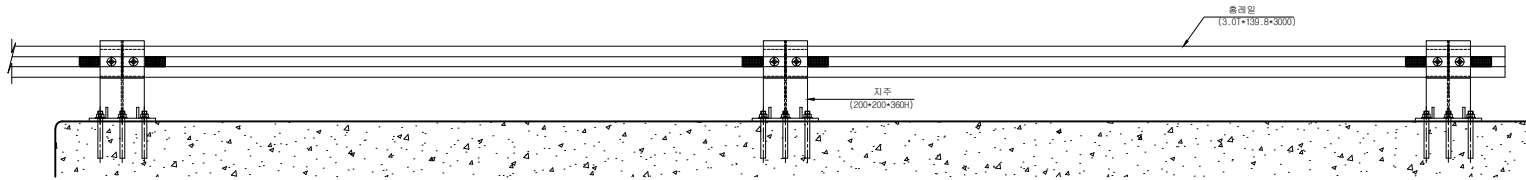

RAIL ELEVATION
SCALE: NONE

SIDE ELEVATION
SCALE: NONE

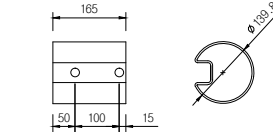
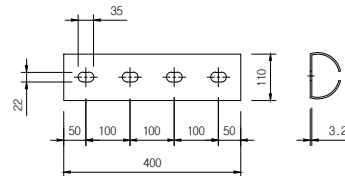
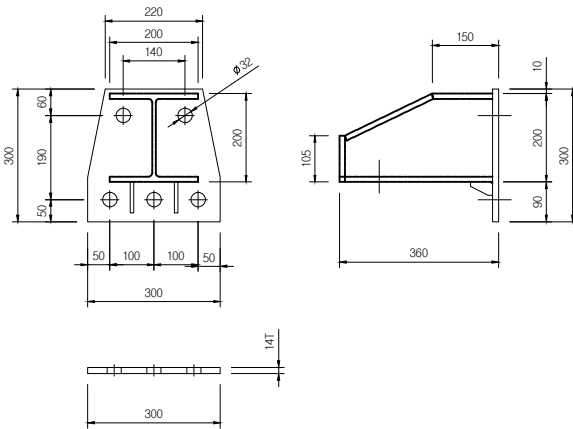

연결대
SCALE: NONE

단부레일
SCALE: NONE

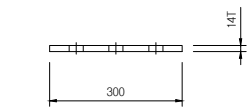

BASE PLATE
SCALE: NONE

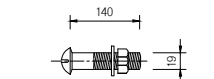

취부볼트
SCALE: NONE

표준구간 (경간당)

품명	규격	단위	수량	비고
총레일	3.0T+φ139.8*3,000L	본	1	용융도금
지주	200*200*360H	조	1	용융도금
연결대	3.2T*110*400L	EA	1	용융도금
취부B/N	φ19*140	SET	4	용융도금
양카B/N	φ24*260	SET	5	용융도금
삼각반사체	40*90	EA	2	-

단부구간 (개소당)

품명	규격	단위	수량	비고
지주	200*200*360H	조	1	용융도금
연결대	3.2T*110*400L	EA	1	용융도금
취부B/N	φ19*140	SET	4	용융도금
양카B/N	φ24*260	SET	5	용융도금
삼각반사체	40*90	EA	2	-
단부레일	3.0T+φ139.8*165	EA	1	용융도금

도면명 Drawing	1단강재방호책 (노측용)	설계 Design	날짜		도면번호
공사명 Project		제도 Drawing	축척	NON	KDSB-05

(주)금동강건



KUMDONG

경남 밀양시 초동면 명성리 2467번지 초동농공단지 내
TEL: (055)-391-1717, FAX: (055)-391-4600
도로안전시설물 전문 생산업체