

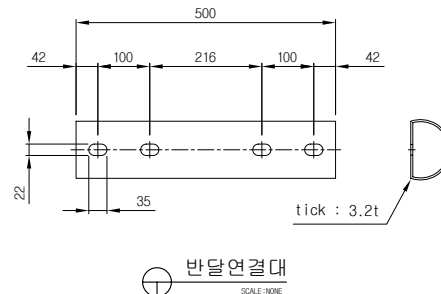

경관형 가드레일 (KDGP-03)-SB3등급 (예정)

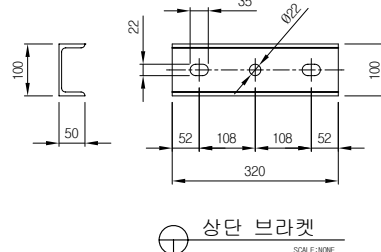
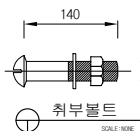
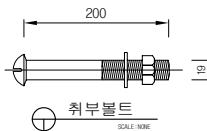
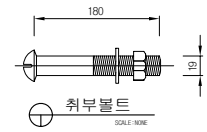
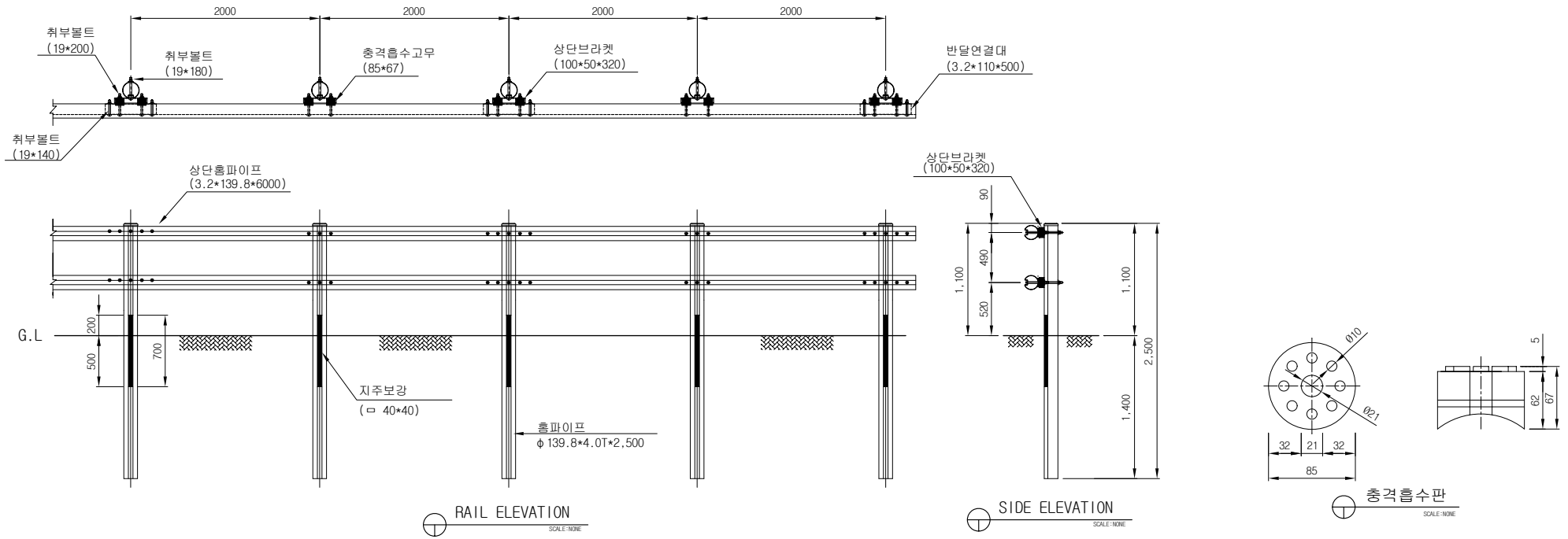

재료표

품명	규격	단위	수량	비고
지주레일	3.2T*139.8*4.000	본	2	용용도금
지주	φ 139.8*4.0T*2.500	본	2	용용도금
주주램	φ 139.8용	EA	2	용용도금
취부B/N	φ 19*200	EA	8	용용도금
취부B/N	φ 19*180	EA	4	용용도금
취부B/N	φ 19*140	EA	4	용용도금
반달연결대	3.2T*110*500	EA	2	용용도금
상단브라켓	100*50*320	EA	4	용용도금
충격흡수판	φ 85*67	EA	8	용용도금

도면명 Drawing	경관형가드레일	설계 Design	주식회사 금동강건	날짜	도면번호	(주)금동강건  경남 밀양시 초동면 명성리 2467번지 초동농공단지 내 TEL: (055)-391-1717, FAX: (055)-391-4600 도로안전시설물 전문 생산업체
공사명 Project		제도 Drawing		축척	KDGP-03	